

quick guide next1

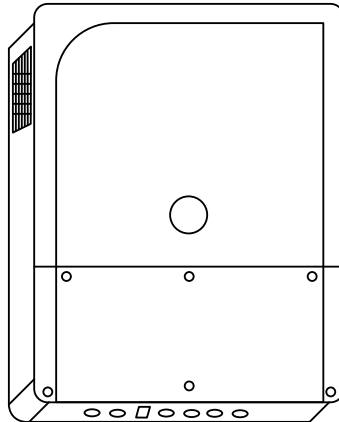

Introduction

EN Congratulations!

You are about to install and use a high-end equipment that will play a central role in the energy management of your battery-based system. The next1 is our single phase smart battery inverter/charger with advanced functions. This product has been designed, manufactured, assembled and tested in our factory in Switzerland.

FR Félicitations !

Vous vous préparez à installer et à utiliser un appareil haut de gamme qui jouera un rôle central dans la gestion d'énergie de votre système avec stockage. Le next1 est notre onduleur/chargeur de batterie monophasé intelligent doté de fonctions avancées. Ce produit a été conçu, fabriqué, assemblé et testé dans notre usine en Suisse.

DE Herzlichen Glückwunsch!

Wir freuen uns, dass Sie sich für eines High-Tech-Gerät entschieden haben, welches bei der Energie-management Ihrer Anlage entscheidende Rolle spielen wird. Der next1 ist unser einphasiger intelligenter Batteriewechselrichter/Ladegerät mit erweiterten Funktionen. Dieses Produkt wurde in unserem Werk in der Schweiz entwickelt, hergestellt, montiert und getestet.

ES ¡Enhorabuena!

Está a punto de instalar y de utilizar un equipo de alta gama que desempeñará una función esencial en la gestión de energía de su sistema con almacenamiento. El next1 es nuestro inversor/cargador de baterías inteligente monofásico que incorpora las funciones más avanzadas. Este producto ha sido diseñado, fabricado, ensamblado y probado en nuestra fábrica en Suiza.

Options & accessories:



nx interface
next1 user interface



nx tempSensor
battery temperature sensor

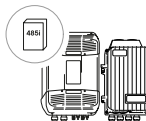

nx vario
solar charger controller



nx powermeter
AC meter for advanced EM

See more about our warranty conditions
on our website studer-innotec.com/studer-care

General Information

EN Exclusion of liability

Studer disclaims all responsibility and liability for damage, costs or losses resulting from an installation that does not comply with the instructions, a faulty operation or inadequate maintenance. The use of studer equipment is in any case under the responsibility of the customer.

Read carefully the safety and operation instructions / Installation must be entrusted to qualified personnel / Check the user manual

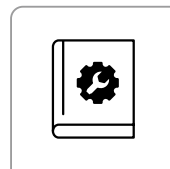

FR Exclusion de la responsabilité

Studer décline toute responsabilité pour les dommages, les coûts ou les pertes résultant d'une installation non conforme aux prescriptions, d'un fonctionnement défectueux, ou d'un entretien déficient. L'utilisation des appareils studer relève dans tous les cas de la responsabilité du client.

Lisez attentivement les instructions de sécurité et d'utilisation / L'installation doit être confiée à du personnel qualifié / Consultez le manuel d'utilisation



DE Haftungsausschluss

Studer übernimmt keinerlei Verantwortung und Haftung für Schäden, Kosten oder Verluste, die sich aus unsachgemäßer Installation, unsachgemäßem Betrieb sowie fehlerhafter Wartung ergeben oder in irgendeiner Art und Weise damit zusammenhängen. Der Einsatz und Betrieb der studer-Geräte obliegt in jedem Fall der Verantwortung des Kunden.

Lesen Sie die Sicherheits- und Betriebsanweisungen sorgfältig durch / Die Installation muss qualifiziertem Personal anvertraut werden / Überprüfen Sie die Bedienungsanleitung



ES Exclusión de responsabilidad

Studer declina cualquier responsabilidad por los daños, costes o pérdidas resultantes de una instalación no conforme con las recomendaciones, de un funcionamiento defectuoso o de un mantenimiento deficiente. El uso de equipos de studer es en cualquier caso responsabilidad del cliente.

Lea atentamente las instrucciones de seguridad y funcionamiento / La instalación debe confiarse a personal cualificado / Consulte el manual de usuario



Mounting and installation

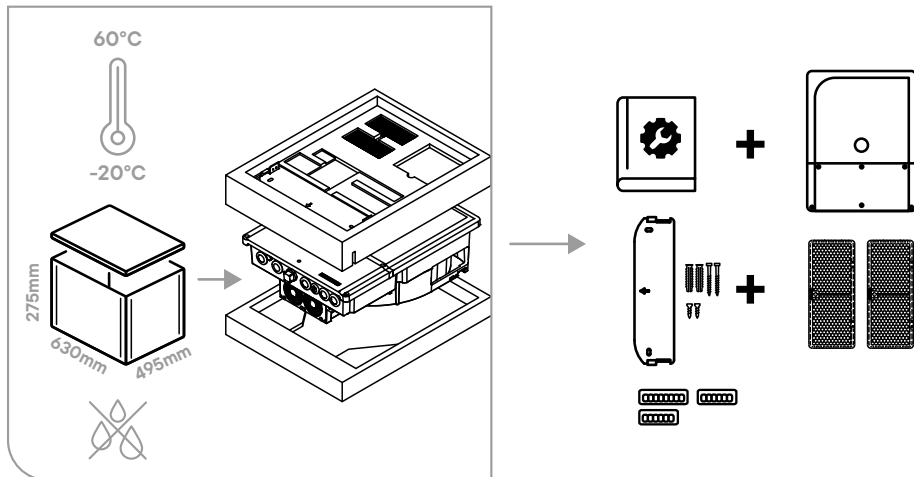

Storage and content

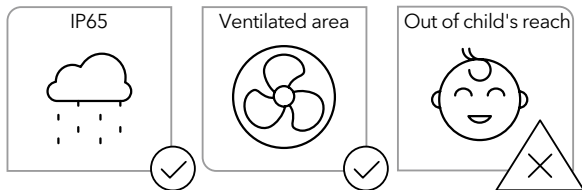

Mounting place

The next1 and batteries should only be installed by qualified personnel.



+ 2x  +  + 

Fixing and dimensions

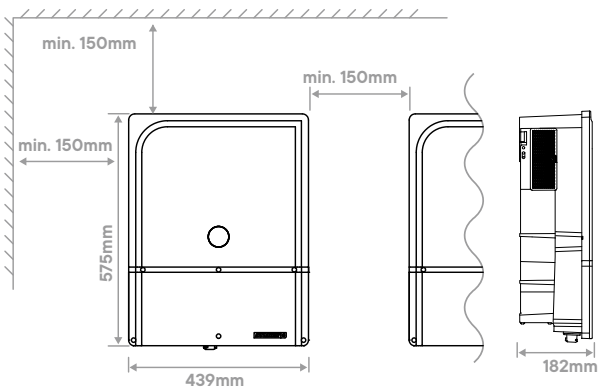
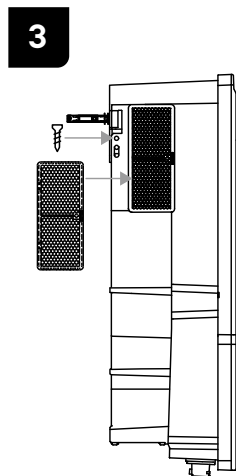
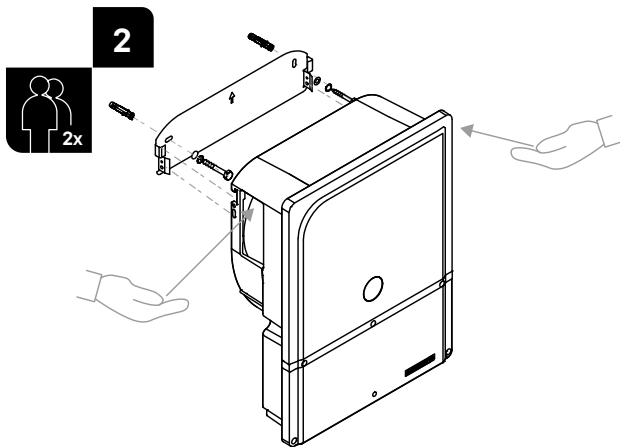
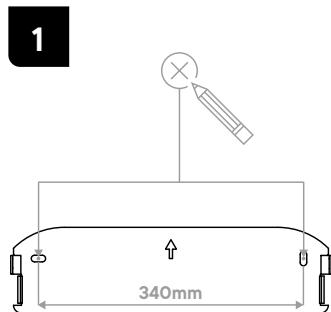

Wiring

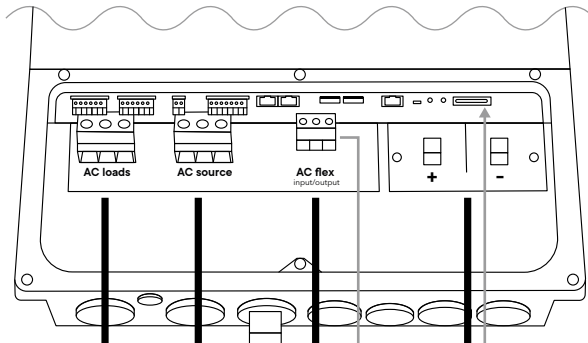
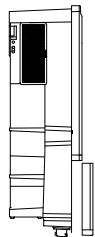
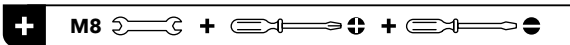

AC

AC load/source up to 2 x 25mm² cable, 3.5Nm
 AC flex up to 2 x 16mm² cable, 1.5Nm

Protection device AC to protect cables, circuit breaker type B

Protection device AC to protect people RCCB/RCD, check earth scheme

Overvoltage protection SPD

AC flex
 programmable
 input/output must
 be configured as
 load for ac-solar

Battery connection

2 x 50mm² cable M8, 9Nm

Protection device
 (battery side)
 300A

BAT+, M8

BAT-, M8



- EN** The device must be installed in accordance with local standards and regulations in force.
- FR** L'appareil doit être installé conformément aux normes et réglementations locales en vigueur.
- DE** Das Gerät muss gemäß den geltenden örtlichen Normen und Vorschriften installiert werden.
- ES** El dispositivo debe instalarse de acuerdo con las normas y regulaciones locales vigentes.

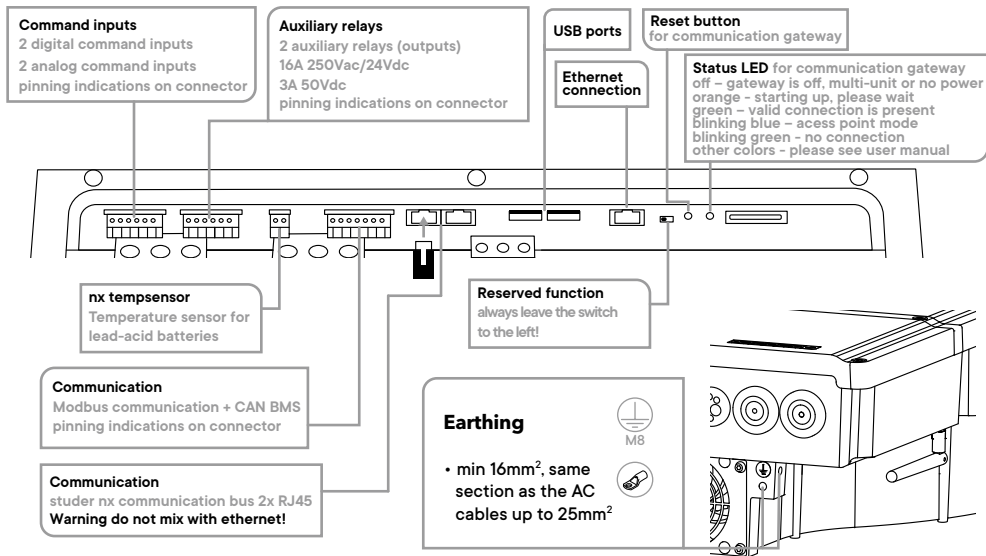

Display

white on – device is on
1x – standby/load search

red off – no error on
on – next1 is off
1x – low battery
2x – overload
3x – high internal temperature
decrease of power output
4x – other warning/error,
check nx interface

off – AC source not present or deactivated
on – AC source present and working
1x – AC source waiting for connection
2x – input maximum allowed power
3x – phases order is incorrect,
or one phase is missing
4x – other warning/error, check nx interface

AC flex as source
off – deactivated, or not present
on – present and working
1x – waiting for connection
2x – source maximum allowed power
3x – phases order is incorrect,
or one phase is missing
4x – other warning/error,
check nx interface

off – no connectivity,
gateway off or starting up

on – Wi-Fi or ethernet connectivity
+ active access point, if not disabled

1x – no available connection
check your network

2x – only access point mode

3x – no valid connection,
contact studer support

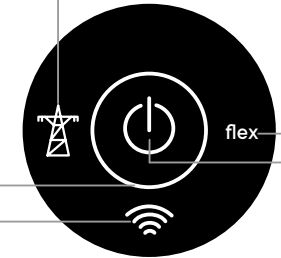

AC flex as load
off – loads ar not powered
on – loads are powered
1x – standby/load search mode
3x – other warning/error,
check nx interface

Manual ON/OFF button
– Clear error
– ON/OFF (1s < push < 3s)
– reset all devices (push > 10s)

Communication setup between units

without nx interface in the communication bus

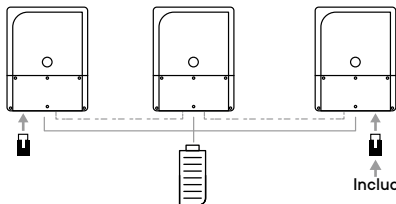

with one nx interface in the communication bus

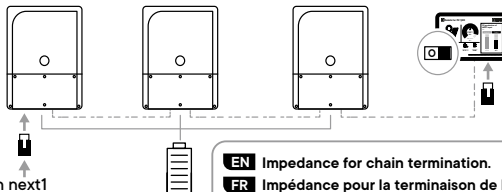

- EN** Impedance for chain termination.
- FR** Impédance pour la terminaison de la chaîne.
- DE** Impedanz für Kettenabschluss.
- ES** Impedancia de terminación de cadena.

Multi units

parallel

Up to 3x next1 in parallel per phase
1 internal transfer, common or separate battery

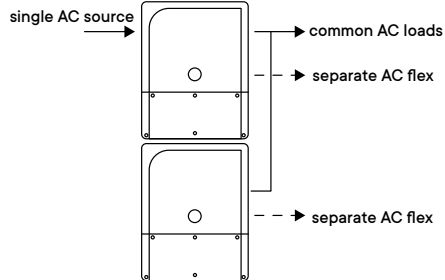

- EN** More information and options in the manual.
- FR** Plus d'informations et d'options dans le manuel.
- DE** Weitere Informationen und Optionen im Handbuch.
- ES** Más información y opciones en el manual del usuario.

biphased / threephased

Up to 3x next1 in parallel per phase
1 internal transfer, common battery

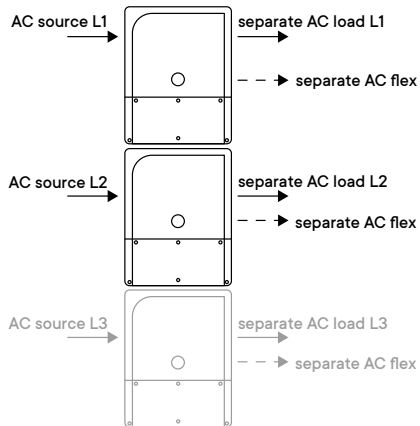

Powering up and configuration via WI-FI

1

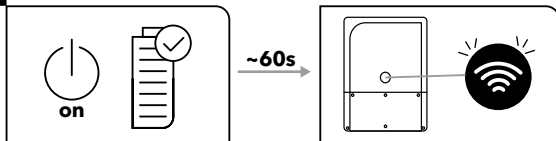

1 with studer monitoring app



EN without the application, page 10

FR sans l'application, page 10

DE ohne die Applikation, Seite 10

ES sin la aplicación, página 10

2 open studer monitoring

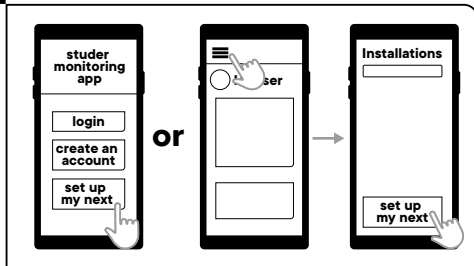

3 follow wizard

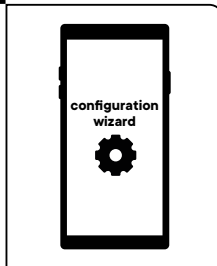

4

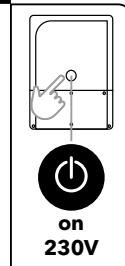

1 configuration without studer monitoring app

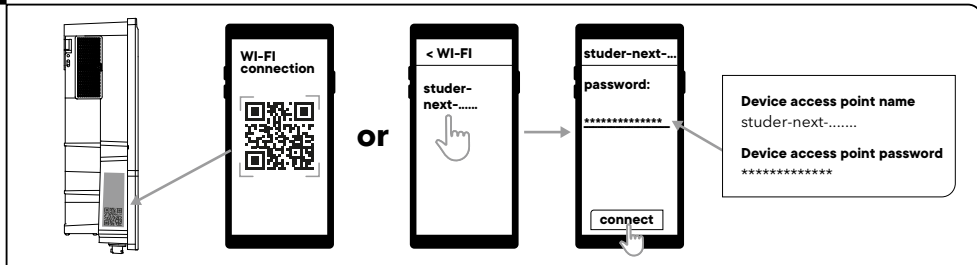

2

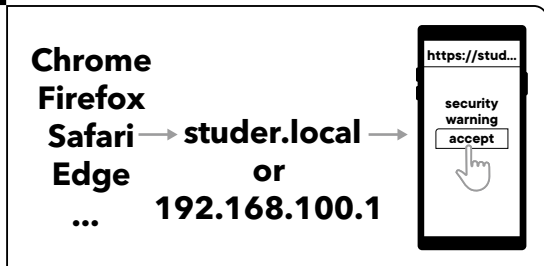

3

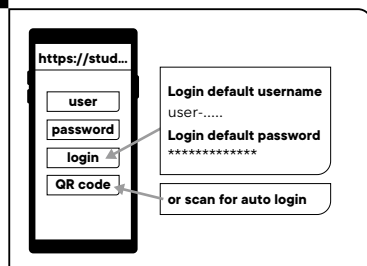

4 follow wizard

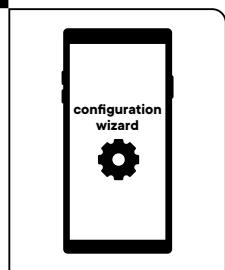

5

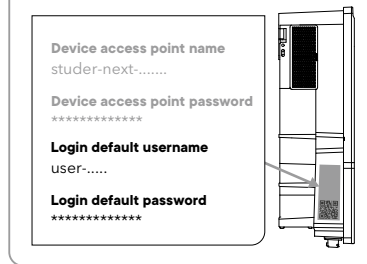
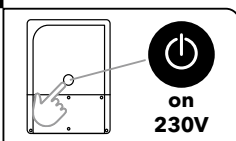

Technical data

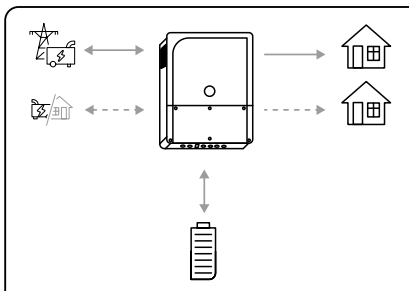

inverter

nx1 6500-48

nx1 4500-48

Continuous Power	4500 VA	3500 VA
Power 30min	6500 VA	4500 VA
Power 5sec	12000 VA	12000 VA
AC output voltage	230V Phase to Neutral	230V Phase to Neutral
AC output frequency	50/60Hz	50/60Hz
Weight/transport weight	39kg/42kg	36kg/39kg
AC output frequency	50/60Hz	50/60Hz
Product dimensions h/w/l	182/439/575mm	182/439/575mm

battery charger

Nominal battery voltage	48 V	48 V
Battery input range	38-68 Vdc	38-68 Vdc
Maximum charging current	125 Adc	87 Adc

transfer

Max rated current	80 Aac	80 Aac
Phase to neutral voltage	230 Vac	230 Vac
Frequency	50/60 Hz	50/60 Hz

IP 65

Protection
Class I



Maintenance and recycling



EN Maintenance and recycling

Except for the periodic check of the connections (tightening, general condition), the next does not require any particular maintenance. To dispose of this product, please use the service for the collection of electrical waste and observe all obligations in force in the place of purchase.

FR Entretien et recyclage

À l'exception du contrôle périodique des branchements (serrage, état général), le next ne nécessite pas d'entretien particulier. Pour vous débarrasser de ce produit, veuillez utiliser les services de collecte des déchets électriques et observer toutes les obligations en vigueur selon le lieu d'achat.

DE Wartung und Recycling

Abgesehen von der regelmäßigen Kontrolle der Anschlüsse (Fixierung, allgemeiner Zustand) bedarf der next keinerlei besonderer Wartungsarbeiten. Beachten Sie bei der Entsorgung dieses Gerätes die geltenden örtlichen Vorschriften und nutzen Sie die Sammeldienste/-stellen für Elektro-/Elektronik-Altgeräte.

ES Mantenimiento y reciclaje

A excepción del control periódico de las conexiones (apriete, estado general), el next no requiere un mantenimiento particular. Para la eliminación del producto, acuda a los servicios de recogida de residuos eléctricos y cumpla todas las obligaciones vigentes en el lugar de compra.

Call our specialists **+41 27 205 60 80**
or visit **[studer-innotec.com/support](https://www.studer-innotec.com/support)**

Studer Innotec SA
rue des Casernes 57
1950 Sion, Switzerland

info@studer-innotec.com

